



Profesionálne lisovacie kliešte na dutinky **2**



Odizolovacie a rezacie nástroje **3**



Automatické kliešte na odizolovanie a rezanie vodičov **4**



Univerzálne nástroje pre telekomunikačnú techniku **4**

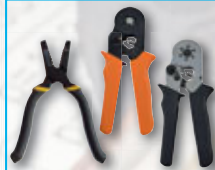

Lisovacie kliešte na izolované, neizolované dutinky a dvojité dutinky **5**



Lisovacie nástroje na izolované káblové oká **6**



Lisovacie kliešte na neizolované káblové koncovky **6**



Robustné lisovacie kliešte na neizolované káblové koncovky **7**



Lisovacie kliešte na mosadzné káblové koncovky **7**



Ručné hydraulické lisy **8**



Akumulátorové hydraulické lisy **9**



Nabíjačka k akumulátorom **9**



Akumulátor k hydraulickým lisom **9**



Hydraulické rezacie nástroje **10**



Rezacie nástroje k Cu a Al káblom **11**



Nástroje na rezanie Cu a Al káblov a vodičov **12**



Kombinované kliešte s izoláciou do 1000 V~ **12**

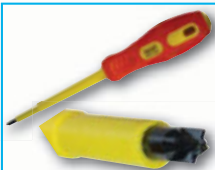

Univerzálne skrutkovače „kombiprofil“ s izoláciou do 1000 V~ **13**

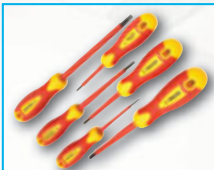

Súprava skrutkovačov s izoláciou do 1000 V **13**



Nástroje k inštalácii sťahovacích pásov **14**



Prefahovacie struny vodičov do elektroinštalčných rúr a trúbiek **14**



Teplovzdušná pištoľ **15**



Súprava nástrojárskejších klieští **15**



Blankovací nôž so slzou **15**





Káblové odizolovacie nástroje **15**

B/O Vysvetlenie piktogramov hlavičky tabuliek

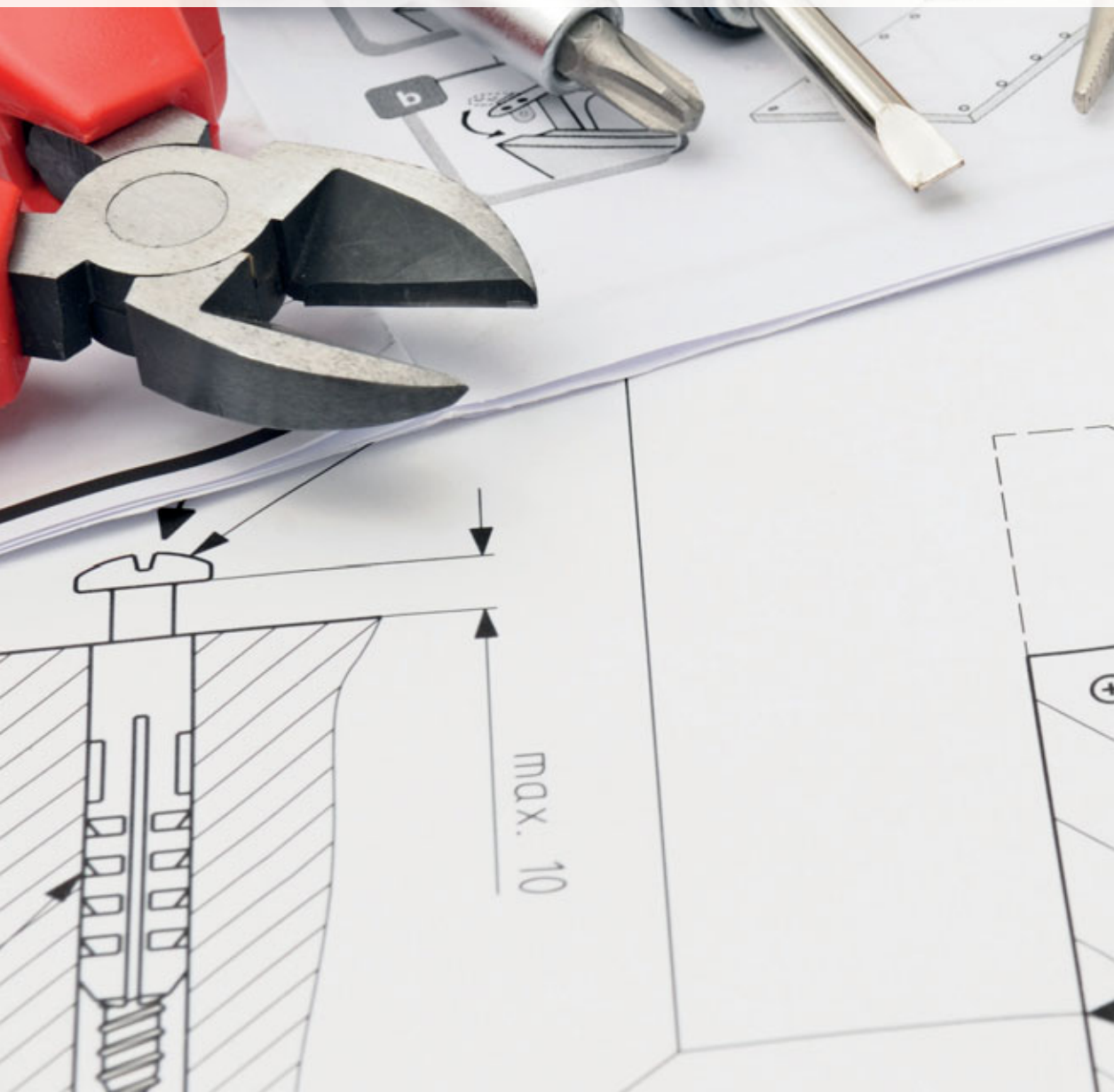
 Hmotnosť	 Teplota okolia	 Typ hlavic skrutkovačov	 Dĺžka náradia
 Max. rezný prierez	 Max. rezný priemer	 Lisovací rozsah	 Prierez zapojiteľných vodičov
 Zdvih piestu	 Kapacita vyrezávania	 Max. lisovacia sila	 Hlavica je otočiteľná o 360°
 Kapacita akumulátora	 Napätie akumulátora	 Typ akumulátora	 Nastaviteľná napínacia sila
 Šírka rezania	 Poznámky, vysvetlivky	 Menovité napätie	 Menovitý výkon



Profesionálne lisovacie kliešte na izolované, neizolované dutinky a dvojité dutinky

TRACON	 mm ²		
F6L	0,5-6	205 mm	470 g
F25L	6-25	240 mm	620 g
F50L	35-50	240 mm	620 g

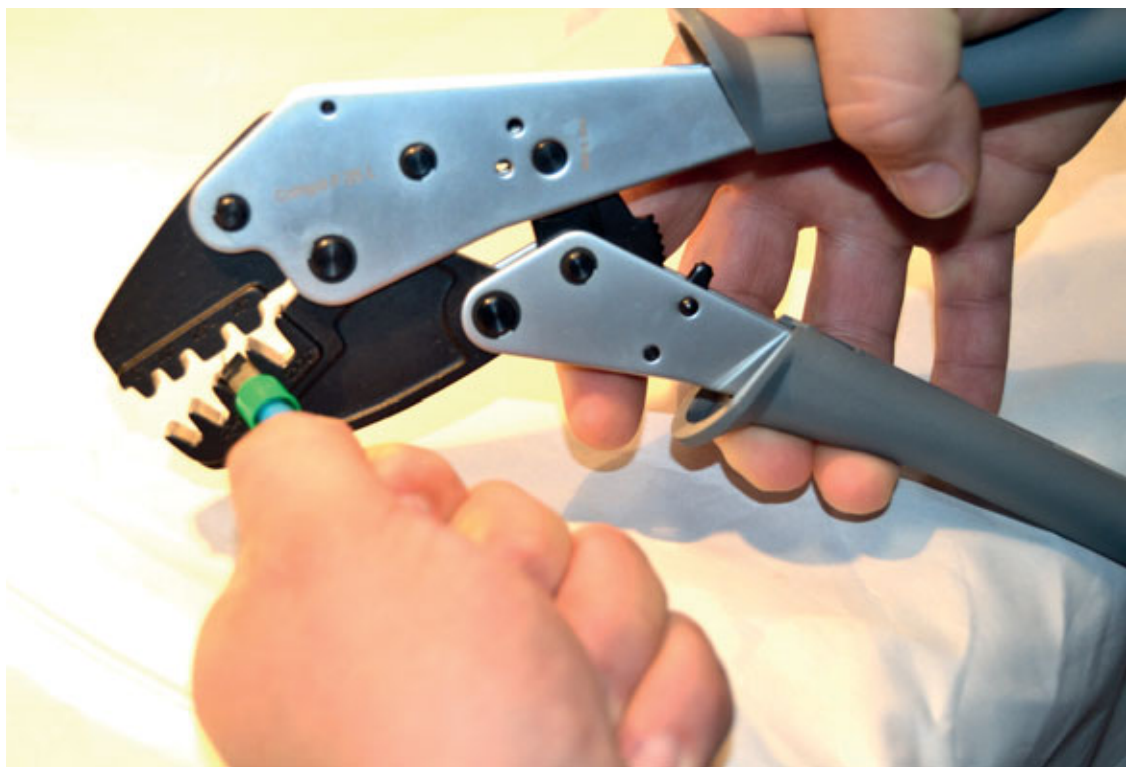

Odizolovacie a rezacie náradie

TRACON	 mm ²		
MACS6	0,08-6	205 mm	180 g
MACS16	6-16	205 mm	180 g



Súprava náradia na lisovanie konektorov SOLAR11-4AB a SOLAR11-4N

TRACON	 mm ²		
SOLAR11-PT	2,5-6	270 mm	725 g / 1710 g





NAČÍTAJTE KÓD!

- Pozrite si naše novinky!
- Buďte informovaný!

Náš sortiment sa neustále a rýchlo rozrastá.
 Predložený katalóg odráža stav k aprílu 2019.
 Pre aktuálne informácie, prosím,
 navštívte našu internetovú stránku!

Kliešte na odizolovanie a rezanie vodičov

TRACON	 mm ²		
TKCS	0,1-4 (6)	200 mm	175 g
TP700A	0,25-2,5	180 mm	380 g
TP700B	0,75-6	180 mm	380 g
LY731	0,5-6	200 mm	300 g



TKCS



TP700A





TP700B



LY731

Rezacie, odizolovacie a lisovacie náradie pre telekomunikačnú techniku

TRACON			
RJ86	220 mm	310 g	RJ11, RJ12, RJ45
RJ468	220 mm	200 g	RJ11, RJ12, RJ45, RJ50
RG317	230 mm	200 g	BNC, TNC, RG 1,72 / 2,6 / 5,4 / 6,5 / 8,1 mm



RJ86



RJ468



RG317



NAČITAJTE KÓD!

- Pozrite si naše novinky!
- Buďte informovaný!

Náš sortiment sa neustále a rýchlo rozrastá. Predložený katalóg odráža stav k aprílu 2019. Pre aktuálne informácie, prosím, navštívte našu internetovú stránku!



Lisovacie kliešte na izolované, neizolované dutinky a dvojité dutinky

TRACON	mm ² 		
9039	6-16	230 mm	600 g
9102-LT	0,25-2,5	145 mm	160 g
9004-LT	0,5-16	180 mm	320 g
9039A-SPEC	0,25-6	175 mm	400 g
9039B-SPEC	6-16	210 mm	470 g
9039-HEXA	0,25-6	175 mm	400 g
9039A	1,5-6	230 mm	600 g
9039AR	0,5-6	230 mm	600 g
9039BR	10-35	230 mm	600 g
9039B	10-35	230 mm	600 g

Vysvetlivky
piktogramov **B/O**



Univerzálne lisovacie kliešte k izolovaným kábovým koncovkám

TRACON	 mm ²		
LY35C	10-35	490 mm	2.150 g
9006RS	0,5-2,5	230 mm	600 g
9006R	2,5-6	230 mm	600 g
9006	2,5-6	230 mm	600 g





Lisovacie kliešte na neizolované kábové koncovky typu SZ, CL, TH, CS a V

TRACON	 mm ²		
HD156R	1,5-6	225 mm	540 g
HD156	1,5-6	247 mm	540 g
KH8	1,5-10	280 mm	470 g
KH14	6-16	280 mm	470 g
KH16	1,5-16	280 mm	470 g



Robustné lisovacie kliešte na neizolované káblové koncovky

TRACON	 mm ²		
KH120	10-95	645 mm	3.000 g
HX50B*	6-50	390 mm	1.300 g
HX120B*	10-120	630 mm	4.000 g
HX150B*	25-150	650 mm	3.200 g

* Lisovací rozsah závisí od typu použitej káblvej koncovky



KH120

HX50B
HX120B
HX150B

HX50B-FEJ
Náhradné čeluste – 1 pár
k lisovaciemu náradiu HX50B
na Cu a Al neizolované koncovky





HX120B-FEJ
Náhradné čeluste – 1 pár
k lisovaciemu náradiu HX120B
na Cu a Al neizolované
koncovky



HX150B-FEJ
Náhradné čeluste – 1 pár
k lisovaciemu náradiu HX150B
na Cu a Al neizolované
koncovky



Lisovacie kliešte na mosadzné káblové koncovky

TRACON	 mm ²		
LY03BR	0,5-6	230 mm	600 g
LY03B	0,5-6	230 mm	600 g



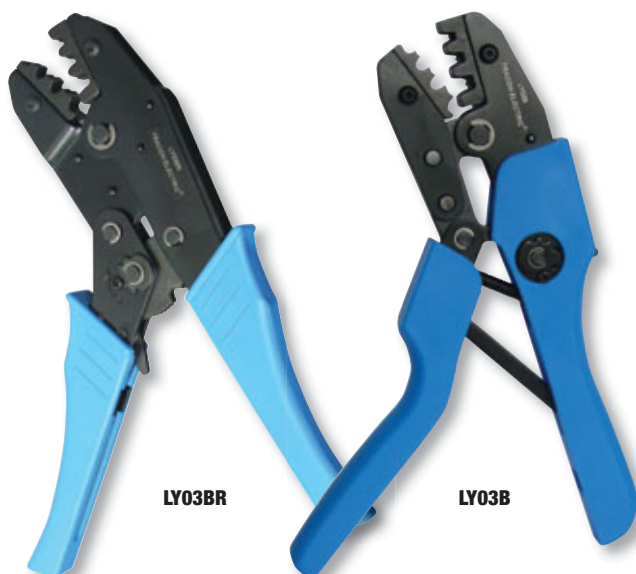

 Vysvetlivky
piktogramov **B/0**



LY03BR

LY03B

Ručné hydraulické lisy



TRACON	 mm ²	 kN max			
D31*	4-95	35	360°	200 mm	1.550 g
D51*	10-185	55	180°	365 mm	2.500 g
D52F*	10-240	67	180°	375 mm	2.800 g
C120F*	16-400	120	180°	590 mm	7.000 g
KHP70**	4-70	50	–	375 mm	3.000 g
KHP240**	16-240	120	–	480 mm	6.250 g

* Príslušenstvo: Plastová prenosná taška

** Príslušenstvo: Plastová prenosná taška + lisovacie čeľuste





Čeľustné vložky (páry) k hydraulickému lisu D31

TRACON		Cu  mm ²	Al  mm ²
D31-4	KZ 4	4	-
D31-6	KZ 5	6	4
D31-10	KZ 6	10	6
D31-16	KZ 8	16	10
D31-25	KZ 10	25	16
D31-35	KZ 12	35	25
D31-50	KZ 14	50	35
D31-70	KZ 16	70	50
D31-95	KZ 18	95	70





Čeľustné vložky (páry) k hydraulickému lisu D52F

TRACON	Cu  mm ²	Al  mm ²
D52F-1016	10-16	10
D52F-2535	25-35	16-25
D52F-5070	50-70	50-35
D52F-95120	95-120	70-95
D52F-150	150	120
D52F-185	185	150
D52F-240	240	185





Čeľustné vložky (páry) k hydraulickému lisu C120F

TRACON	Cu  mm ²	Al  mm ²
C120F-16	16	-
C120F-25	25	16
C120F-35	35	25
C120F-50	50	35
C120F-70	70	50
C120F-95	95	70
C120F-120	120	95
C120F-150	150	120
C120F-185	185	150
C120F-240	240	185
C120F-300	300	240
C120F-400	400	300







Čeľustné vložky (páry) k hydraulickému lisu D51

TRACON		Cu  mm ²	Al  mm ²
D51-10-120	KZ 6	10	6
	KZ 20	120	95
D51-16-70	KZ 8	16	10
	KZ 16	70	50
D51-25-95	KZ 10	25	16
	KZ 18	95	70
D51-35-50	KZ 12	35	25
	KZ 14	50	35
D51-150	KZ 22	150	120
D51-185	KZ 25	185	150



Akumulátorové hydraulické lisy

TRACON	 mm ²	 kN max			
D31E	4-95	35	360°	200 mm	1.550 g
D55E	10-185	55	340°	315 mm	3.250 g
D62E	6-240	62	340°	320 mm	3.550 g

Príslušenstvo:

- Nabíjačka k akumulátorom, AKKUT1
- Akumulátor, AKKU1
- Kovový prenosný kufrík

Čeľustné vložky (páry) k hydraulickému lisu D62E

TRACON		Cu mm ²	Al mm ²
D62-10	KZ 6	10	6
D62-16	KZ 8	16	10
D62-25	KZ 10	25	16
D62-35	KZ 12	35	25
D62-50	KZ 14	50	35
D62-70	KZ 16	70	50
D62-95	KZ 18	95	70
D62-120	KZ 20	120	95
D62-150	KZ 22	150	120
D62-185	KZ 25	185	150
D62-240	KZ 28	240	185
D62-300	KZ 32	300	240



Čeľustné vložky (páry) k hydraulickému lisu D31E

TRACON		Cu mm ²	Al mm ²
D31-4	KZ 4	4	-
D31-6	KZ 5	6	4
D31-10	KZ 6	10	6
D31-16	KZ 8	16	10
D31-25	KZ 10	25	16
D31-35	KZ 12	35	25
D31-50	KZ 14	50	35
D31-70	KZ 16	70	50
D31-95	KZ 18	95	70







Čeľustné vložky (páry) k hydraulickému lisu D55E

TRACON		Cu mm ²	Al mm ²
D51-10-120	KZ 6	10	6
	KZ 20	120	95
D51-16-70	KZ 8	16	10
	KZ 16	70	50
D51-25-95	KZ 10	25	16
	KZ 18	95	70
D51-35-50	KZ 12	35	25
	KZ 14	50	35
D51-150	KZ 22	150	120
D51-185	KZ 25	185	150





Nabíjačka k akumulátorom

TRACON				
AKKUT1	230 V AC	18 V	2100 mAh	Li-ion



Akumulátor

TRACON			
AKKU1	18 V	2000 mAh	Li-ion



Hydraulický rezací lis



TRACON	kN max	Imax	a	m
HKS-15	150 kN	max. 2-3 mm	25 mm	6.2 kg

- Súčasti lisu:
- Rezacie čeluste: Ø21,8mm; Ø27,6mm; Ø34,1mm; Ø42,7mm; Ø48,7mm; Ø60,5mm; □32×32mm
 - Plastový kufor

Používa sa na vyrezávanie kruhových otvorov na oceľovo-plechových rozvodných skrinách, montážnych paneloch. Uľahčuje montáž ovládacích hlavíc, kontroliek, tlačidiel, spínačov. Možnosť vyrezávania štvorcových výrezov pre panelové meracie prístroje ako aj otvorov pre prechodky na prírubách oceľových rozvádzačov.



Príslušenstvo k hydraulickému rezaciemu lisu HKS-15



TRACON		
HKS-15-20	Prechodka MG20	Ø20 mm
HKS-15-22	Ovládacia hlavica Ø22 mm	Ø22 mm
HKS-15-25	Prechodka MG25	Ø25 mm
HKS-15-32	Prechodka MG32	Ø32 mm
HKS-15-40	Prechodka MG40	Ø40 mm
HKS-15-50	Prechodka MG50	Ø50 mm
HKS-15-63	Prechodka MG63	Ø63 mm
HKS-15-PG13,5	Prechodka PG13,5	Ø20 mm
HKS-15-PG16	Prechodka PG16	Ø23,5 mm
HKS-15-PG21	Prechodka PG21	Ø29,5 mm
HKS-15-PG29	Prechodka PG29	Ø36 mm
HKS-15-PG36	Prechodka PG36	Ø46 mm
HKS-15-PG42	Prechodka PG42	Ø51 mm
HKS-15-PG48	Prechodka PG48	Ø59 mm
HKS-15-43×43	Panelový prístroj s rámom 48×48 mm	□43×43 mm
HKS-15-68×68	Panelový prístroj s rámom 72×72 mm	□68×68 mm
HKS-15-92×92	Panelový prístroj s rámom 96×96 mm	□92×92 mm
HKS-15-BSZ10	Uťahovacia skrutka, 105 mm	max. 2-3 mm

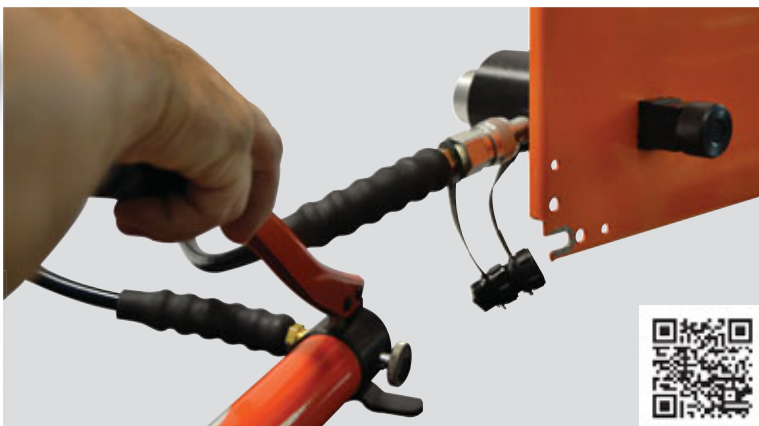

Rezacie náradie k Cu a Al káblom

TRACON	d_{max} 	NYN 	NYN 	NYCWY 	NAYN 	NAYN 	AYCWY
RKV300	35 mm	max. 4×50	max. 1×240	max. 4×50/25	max. 4×70	max. 1×300	max. 4×50/25
RKV700	60 mm	max. 4×95	max. 1×240	max. 4×95/50	max. 4×120	max. 1×300	max. 4×95/35
RKV1000	95 mm	-	-	max. 4×240/120	max. 4×240	max. 1×500	-



RKV300



RKV700



Teleskopická rukoväť

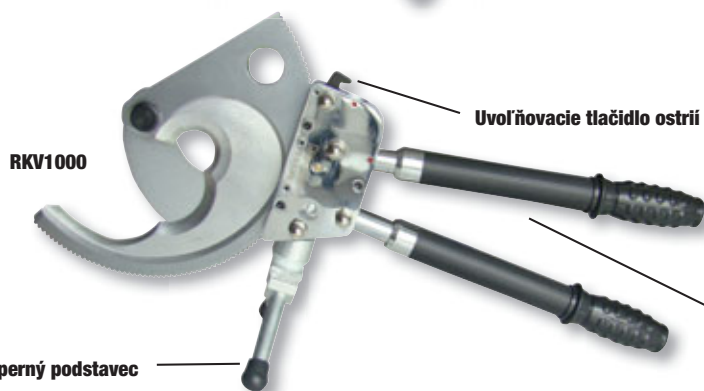

Uvoľňovacie tlačidlo ostrií

RKV1000

Podperný podstavec



Teleskopická rukoväť



Náradie na rezanie Cu a Al káblov a vodičov

TRACON	A _{max} 	d _{max} 		
CC22	16 mm ²	5,5 mm	150 mm	190 g
CC38	25 mm ²	6,5 mm	210 mm	350 g
CC60	35 mm ²	8 mm	230 mm	510 g
CC80	70 mm ²	9 mm	235 mm	510 g
CC100	100 mm ²	15 mm	320 mm	500 g
CC250	250 mm ²	17 mm	600 mm	1250 g
CC500	500 mm ²	25 mm	800 mm	2850 g



Kliešte s izoláciou do 1000 V~



TRACON			
KF-1000	160 mm	230 g	kombinované kliešte
KF-1000-2	200 mm	370 g	kombinované kliešte
KB-1000	160 mm	230 g	odizolovacie kliešte
KC-1000	160 mm	210 g	cvikacie kliešte
KL-1000	160 mm	230 g	ploché kliešte

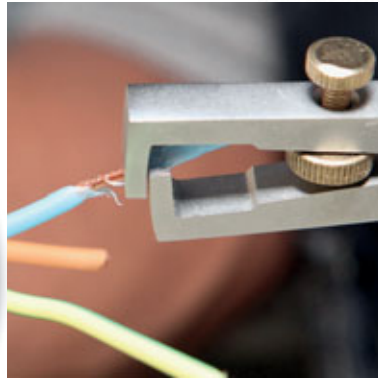

RELEVANT STANDARD
EN 60900



Skrutkovače s izoláciou do 1000 V~

TRACON		
SD375F		3×75 mm
SD4100F		4×100 mm
SD5125F		5×125 mm
SD6100F		6×100 mm
SD6125F		6×125 mm
SD6150F		6×150 mm
SD375S		3×75 mm (PH0)
SD4100S		4×100 mm
SD5125S		5×125 mm (PH1)
SD6100S		6×100 mm (PH2)
SD6125S		6×125 mm (PH2)
SD6150S		6×150 mm (PH2)



RELEVANT STANDARD
EN 60900



Univerzálne skrutkovače „kombiprofil“ s izoláciou do 1000 V~

TRACON		
SDDK4100S		4×100 mm
SDDK5125S		5×125 mm (PZ1)
SDDK6150S		6×150 mm (PZ2)

Skrutkovače majú špeciálne vytvarovaný hrot umožňujúci doťahovanie svorkových skrutiek používaných v elektromeroch, ističoch, stykačoch nachádzajúcich sa v sortimente spoločnosti Tracon Slovakia, s.r.o.

Integrujú výhody hrotov plochého a križového skrutkovača, čo umožňuje ľahšie a bezpečnejšie doťahovanie svoriek prístrojov.





VDE TEST REPORT NO.:
40011797



RELEVANT STANDARD
EN 60900





Súprava skrutkovačov s izoláciou do 1000 V~

TRACON			
KSET1000	1.0 × 5.5 × 125 mm	PH2 × 100 mm	
	0.8 × 4.0 × 100 mm	PH1 × 80 mm	
	0.4 × 2.5 × 75 mm	PH0 × 60 mm	



Náradie k inštalácii sťahovacích pásov

TRACON		
TG007	2.2-8 mm	220 g
TG008	2.2-4.8 mm	320 g
TG010	3.6-13 mm	380 g



TG008





TG007

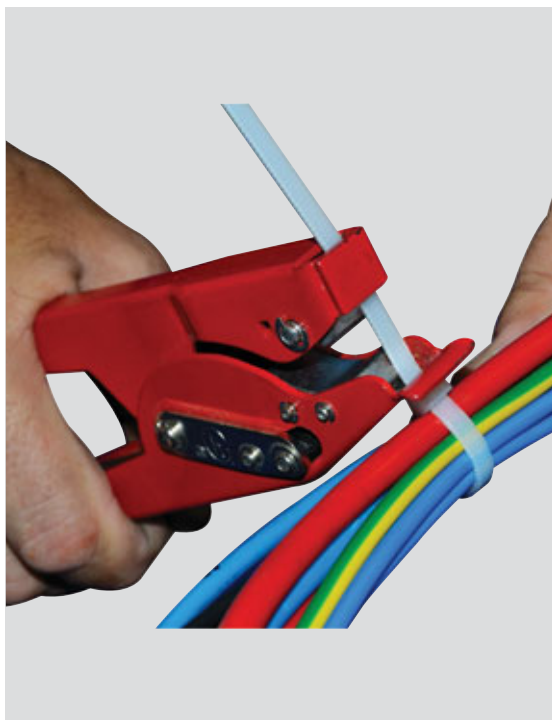

TG010



Preťahovacie struny vodičov do elektroinštaláčnych rúr a trubiek

TRACON			
TBSZ-5	5 m		Plastová struna, s kovovou hlavicou a slučkou
TBSZ-10	10 m	$\varnothing = 3 \text{ mm}$	
TBSZ-20	20 m		
TBSZS-5	5 m		Oceľová špirála
TBSZS-10	10 m	$\varnothing = 3.2 \text{ mm}$	
TBSZS-20	20 m		
TBSZF-5	5 m		Plochá oceľová struna
TBSZF-10	10 m	$d = 3.2 \text{ mm}$	
TBSZF-20	20 m		



Teplovzdušná pištoľ

TRACON

U_n

°C



HLF-02

230 V AC

1.000/2.000 W

350/600 °C

1450 g

300 / 500 l/min

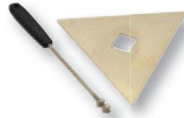

Súprava nástrojárskeho kliešti

TRACON

SP-KLT

- 1 ks cvikacie nástrojárske kliešte čelné
- 1 ks cvikacie nástrojárske kliešte bočné
- 1 ks rovné nástrojárske kliešte
- 1 ks kombinované kliešte



Vysvetlivky piktogramov

B/O

Blankovací nôž so slzou

TRACON



BK-01

160 mm

70 g



Káblové odizolovacie náradie

TRACON

max.
∅

KBY

200 mm

12 mm

95 g



NAČÍTAJTE KÓD!

- Pozrite si naše novinky!
- Buďte informovaný!

Náš sortiment sa neustále a rýchlo rozrastá.
Predložený katalóg odráža stav k aprílu 2019.
Pre aktuálne informácie, prosím,
navštívte našu internetovú stránku!